

Signicade® Deluxe		Color	Outside Dimensions	Sign Face	Weight	
Catalog #	140-W	White	46.375"Hx27"Wx3"D	24"W x 36"H	20 lbs.	
	140-BK	Black				

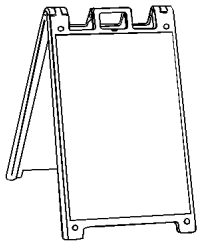

Signicade®		Color	Outside Dimensions	Sign Face	Weight	
Catalog #	130-W	White	45"Hx25"Wx3"D	24"W x 36"H	18 lbs.	
	130-BK	Black				
	130-Y	Yellow				
	130-O	Orange	45"Hx25"Wx3"D	24"W x 36"H	18 lbs.	
	130-R	Red				
	130-B	Blue				
	130-G	Green				



Marquee™		Color	Outside Dimensions	Sign Face	Weight	
Catalog #	2300W	White	41"Hx26"Wx3"D	24.25"Wx36.125"H	18 lbs.	
	2300BK	Black				
	2300R	Red	Please call for availability.			
	2300B	Blue				
	2300G	Green				

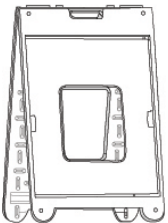

Econo Classic		Color	Outside Dimensions	Sign Face	Weight	
Catalog #	1230R1	White	42.75"Hx26.5W	24"W x 36"H	11.5 lbs.	

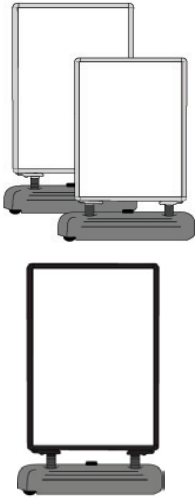

Wind Signs with Snap Frame		Color	Outside Dimensions	Sign Face	Weight	
Catalog #	1866 Wind Sign II Snap Frame	Grey Satin Frame Grey Base	43"H x 28.7"W x 1.3"D	24"W x 36"H	29 lbs.	
	1877 Wind Sign Deluxe Snap Frame	Grey Satin Frame Grey Base	57"H x 30"W x 1.3"D	28"W x 44"H	33 lbs.	
	1877BK Wind Sign Deluxe Snap Frame	Gloss Black Frame Grey Base	57"H x 30"W x 1.3"D	28"W x 44"H	33 lbs.	

NOTE: Wind Sign frames and bases are shipped on separate pallets. 56 Units of the Wind Sign II and Wind Sign Deluxe count as the value of 1 pallet towards our 5 pallet discount pricing.

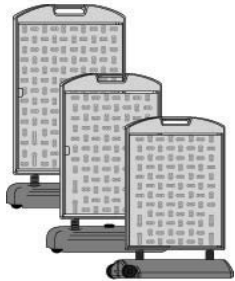

Wind Signs with Quick-Change™ Frame		Color	Outside Dimensions	Sign Face	Weight	
Catalog #	1822 Wind Sign II Quick-Change™ Frame	Grey	53"H x 28.7"W x 2.5"D	24"W x 36"H	25 lbs.	
	1833 Wind Sign Deluxe Quick-Change™ Frame	Grey	61"H x 30"W x 2.5"D	28"W x 44"H	30 lbs.	
Catalog #	1800R2 Wind Sign	Grey	40"H x 26"W x 2.5"D	22"W x 28"H	16 lbs.	

NOTE: Wind Sign frames and bases are shipped on separate pallets. 52 Units of the Wind Sign and 56 Units of the Winds Sign II and Wind Sign Deluxe count as the value of 1 pallet towards our 5 pallet discount pricing.



Sidewalk Sign		Color	Outside Dimensions	Sign Face	Weight	
Catalog #	1600W	White	40.7"Hx30.66W Foot is 16.92"D	24"W x 36"H	10.3 lbs.	
	1600BK	Black				

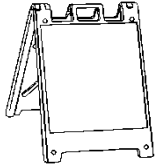

Squarecade™ 36		Color	Outside Dimensions	Sign Face	Weight	
Catalog #	136-W	White	36"Hx25"Wx3"D	24"W x 24"H	17 lbs.	
	136-Y	Yellow				
	136-O	Orange				

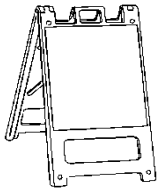

Squarecade™ 45		Color	Outside Dimensions	Sign Face	Weight	
Catalog #	145-W	White	45"Hx25"Wx3"D	24"W x 24"H	18 lbs.	
	145-Y	Yellow				
	145-O	Orange				

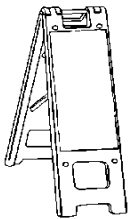

Narrowcade®		Color	Outside Dimensions	Sign Face	Weight	
Catalog #	150-W	White	45"Hx13"Wx3"D	12"W x 24"H	11 lbs.	
	150-Y	Yellow				
	150-O	Orange				

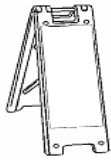

Minicade®		Color	Outside Dimensions	Sign Face	Weight
Catalog #	155-W	White	36"Hx13"Wx3"D	12"W x 24"H	10 lbs.
	155-Y	Yellow			
	155-O	Orange			

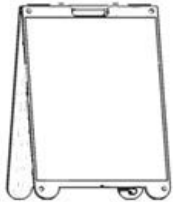

Simpo® Sign		Color	Outside Dimensions	Sign Face	Weight
Catalog #1210W	White	34"Hx23"Wx1.5"D	22"W x 28"H	8 lbs.	
Catalog #1210BK	Black				

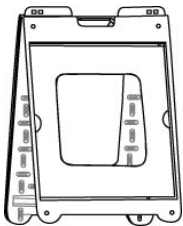

Simpo® Sign II		Color	Outside Dimensions	Sign Face	Weight
Catalog #1225W	White	37.25"Hx24.375"Wx2"D	22"W x 28"H	9.8 lbs.	
Catalog #1225BK	Black				



SimpoSquare® 24		Color	Outside Dimensions	Sign Face	Weight
Catalog #	1240W	White	32.3"Hx26"Wx2"D	24"H x 24"W	5 lbs.
	1240BK	Black			

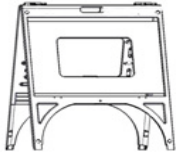

Quik® Sign		Color	Outside Dimensions	Sign Face	Weight
Catalog #	1200W	White	30.5"Hx26"Wx2"D	18"H x 24"W	6.8 lbs.
Catalog #	1200BK	Black			



Realicade®		Color	Outside Dimensions	Sign Face	Weight
Catalog #	170	White	45.5Hx26.5Wx1.375D	18"H x 24"W	3.8 lbs.
	170-5PK	White			
	171	Black			
	171-5PK	Black			



T-Cade™		Color	Outside Dimensions	Sign Face	Weight
Catalog #	181	Black	42.5"H x 17.25"W	Has multiple mounting holes for various size signs	1.8 lbs.

NOTE: Realicades & T-Cades do not qualify toward 5 pallet pricing discounts.

Countertop Sign Frame



Mini Signicade® Deluxe		Color	Outside Dimensions	Sign Face	Weight
Catalog #	140-W-MINI	White	13.75"H x 9.5"W x .875"D (10.5"W when open)	11"H x 8.5"W	.9 lbs.
	140-BK-MINI	Black			
	140-B-MINI	Blue			

Units are packed in individual cartons that are in a master carton of 5 units.
Must purchase in multiples of 5 units of a single color.



Funnel	
Catalog #8185	We recommend using dry play sand to fill sign frames

ACCESSORIES



Message Board 28"W x 44"H		Color	Kit Description
Catalog #	8450	White	Each kit contains 2 white (28" x 44") coroplast boards with white tracks affixed, complete 4" number and letter set (black on white), storage box with letter dividers. Sign frame must be purchased separately.

Message Board 24"W x 36"H		Color	Kit Description
Catalog #	8410	White	Each kit contains 2 white (24" x 36") coroplast boards with white tracks affixed, complete 4" number and letter set (black on white), storage box with letter dividers, and 12 white screws to affix to Signicade and Marquee. Sign frame must be purchased separately.
	8420	Black	Each kit contains 2 black (24" x 36") coroplast boards with black tracks affixed, complete 4" number and letter set (white on black), storage box with letter dividers, and 12 black screws to affix to Signicade and Marquee. Sign frame must be purchased separately.
	8440	White	VALUE KIT - Each kit contains 2 white (24" x 36") coroplast boards with white tracks affixed, complete 4" number and letter set (black on white), and 12 white screws to affix to Signicade and Marquee. Economy storage box (letter dividers not included). Sign frame must be purchased separately.

Message Board 22"W x 28"H		Color	Kit Description
Catalog #	8400	White	Each kit contains 2 (22" x 28") coroplast boards with tracks affixed, complete 3" number and letter set, and storage box with tabs. Sign frame must be purchased separately

ACCESSORIES CONTINUED



Replacement Letter Sets for 24"W x 36"H White Message Board		Color	Set Description
Catalog #	8410RL	White	Replacement 4" Letter Set for 24" x 36" White Message Board. Letters are black on white, with red on white numbers. Set includes letters and numbers only, no box or letter dividers are included.

Replacement Letter Sets for 24"W x 36"H Black Message Board		Color	Set Description
Catalog #	8420RL	Black	Replacement 4" Letter Set for 24" x 36" Black Message Board. Letters are white on black, with day-glow orange on black numbers. Set includes letters and numbers only, no box or letter dividers are included.



Replacement Letter Sets for 22"W x 28"H White Message Board		Color	Kit Description
Catalog #	8400RL	White	Replacement 3" Letter Set for 22" x 28" White Message Board. Letters are black on white, with red on white numbers. Open House, Special, Sale, and Hiring on large headers. No box or letter dividers are included.



Marker Board 24"W x 36"H		Color	Kit Description
Catalog #	8520	White	Each kit contains 2 coroplast boards (24" X 36") with 5 neon wet erase markers. Contains 12 screws to attach boards to the Signicade or Marquee. Markers do not rub off or wash off in the rain. Sign frame must be purchased separately
	8530	Black	

Marker Board 22"W x 28"H		Color	Kit Description
Catalog #	8500	White	Each kit contains 2 coroplast boards (22" X 28") with 5 neon wet erase markers. Markers do not rub off or wash off in the rain. Sign frame must be purchased separately
	8510	Black	

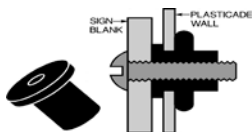

Well Nuts		Description
Catalog #	801	The installation of well nuts on your sign frame makes changing signs easier, by providing permanent mounting holes. Use on the Signicade, Marquee, Marquee Jr., Squarecades, Narrowcade, and Minicade
Catalog #	802	

Available Accessories

	Signicade	Signicade Deluxe	Marquee	Sidewalk Sign	Wind Sign	Wind Sign II Quick-Change	Wind Sign Deluxe Quick-Change	Econo Classic	Simpo Sign	Simpo Sign II
White Message Board	Yes* cat.# 8410 & 8440	Yes cat.# 8410 & 8440	Yes* cat.# 8410 & 8440	Yes cat.# 8410 & 8440	Yes cat.# 8400	Yes cat.# 8410 & 8440	Yes cat.# 8450	Yes cat.# 8410	No	Yes cat.# 8400
Black Message Board	Yes* cat.# 8420	Yes cat.# 8420	Yes* cat.# 8420	Yes cat.# 8420	No	Yes cat.# 8420	No	Yes cat.# 8420	No	No
White Marker Board	Yes* cat.# 8520	Yes cat.# 8520	Yes* cat.# 8520	Yes cat.# 8520	Yes cat.# 8500	Yes cat.# 8520	No	Yes cat.# 8520	No	Yes cat.# 8500
Black Marker Board	Yes* cat.# 8530	Yes cat.# 8530	Yes* cat.# 8530	Yes cat.# 8530	Yes cat.# 8510	Yes cat.# 8530	NO	Yes cat.# 8530	No	Yes cat.# 8510

*must use wood screws (included in kit) to attach to the sign frame or well nuts (sold separately)

DIRECTIONS FOR PREPARING POLYETHYLENE USING FLAME TREATING

1. Fit a propane torch with a flame spreader.
2. Following the operating cautions of the propane torch, ignite the flame.
3. Observe the flame in a darkened room, noting the primary (bright blue) and secondary (faint yellow) portions of the flame (see drawing below).
4. Adjust the flame so that the primary flame is contained within the spreader, and the secondary flame is 1-1/2" beyond the spreader (see drawing below).
5. Treat the polyethylene recess area with the tip of the secondary flame by passing it over the polyethylene in gentle sweeping strokes. Total exposure to the flame should be 2-3 seconds, .5 seconds per stroke. This light exposure should not deform or melt the polyethylene in any way.
6. Test the polyethylene for bond readiness by wetting it with water. If the water runs off immediately, the treatment was not effective. If the water sheets on the surface, the surface is ready for bonding. If unsure, compare the water's action on treated area with the untreated area.
7. We also recommend wiping the sign recess area with isopropyl alcohol within 20 minutes of flame treating to insure positive adhesion.
8. Apply a FULL sheet of adhesive vinyl sheeting within 1 hour after flame treating. If you wish to apply cut out letters or shapes to the sign, you would then apply them to the full sheet.

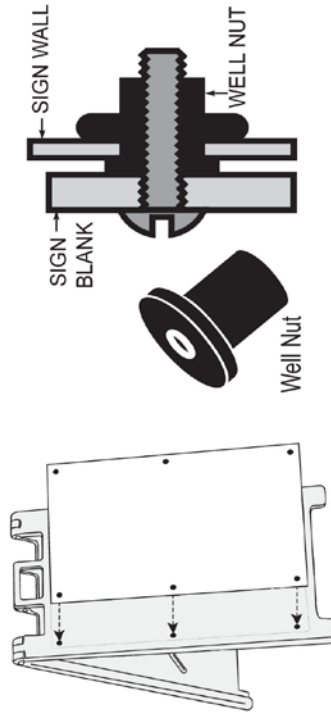

HOW TO ATTACH A BLANK SIGN TO A SIGN FRAME

1. Any wood screw can be used to affix the sign blank to the sign frame. However, if the sign blank is going to be changed many times, we propose using well nuts.
2. Well nuts with screws can be purchased in packs of 20 or 100 units.
3. A hole is drilled and the well nut inserted. Then screw a bolt into it and it expands like a molly in drywall. When the bolt is unscrewed you have a permanent screw receptacle enabling the user to change signs indefinitely.

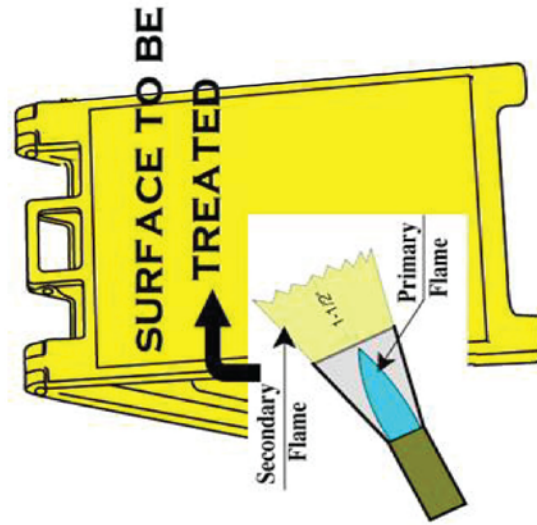

PLASTICADE®